

◆三好市庁舎のご案内

市役所配置図

三好市役所 〒778-8501 三好市池田町シンマチ1500番地2
TEL 72-7600(代)



三好市役所 1階

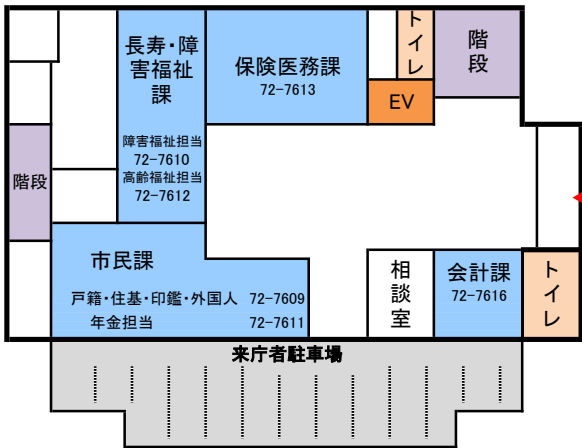

三好市役所 2階

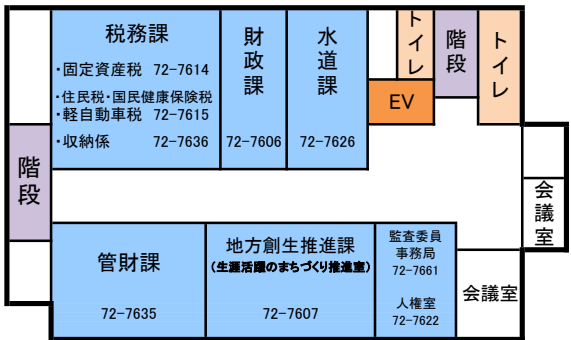

三好市役所 3階

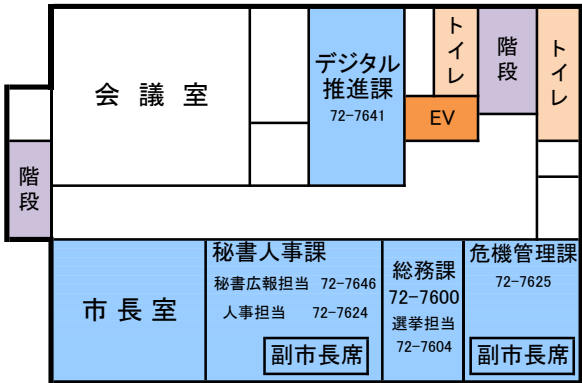

三好市役所 4階

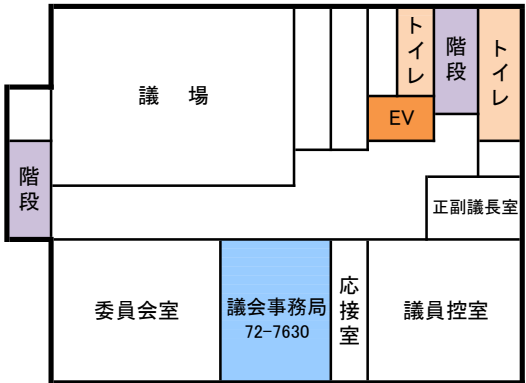

分庁第一庁舎

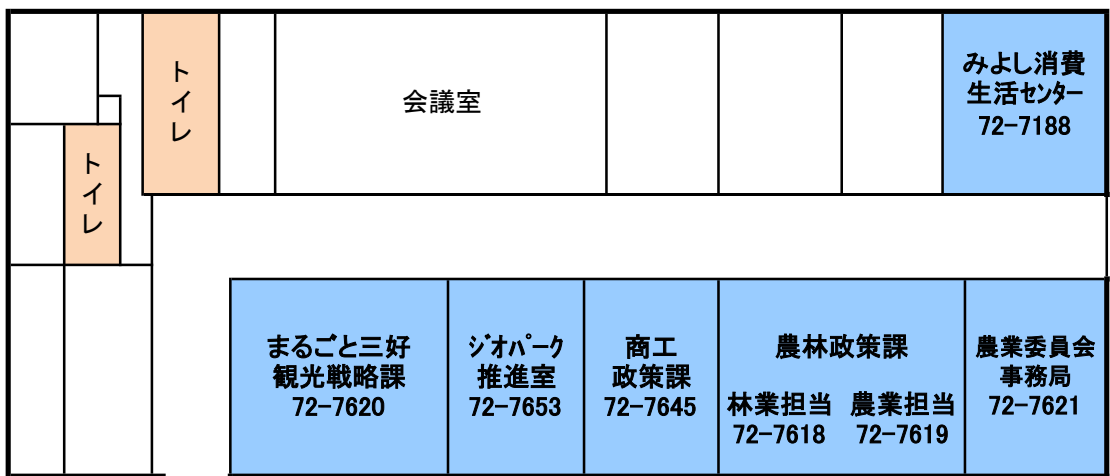

正面玄関

分庁第二庁舎



正面玄関

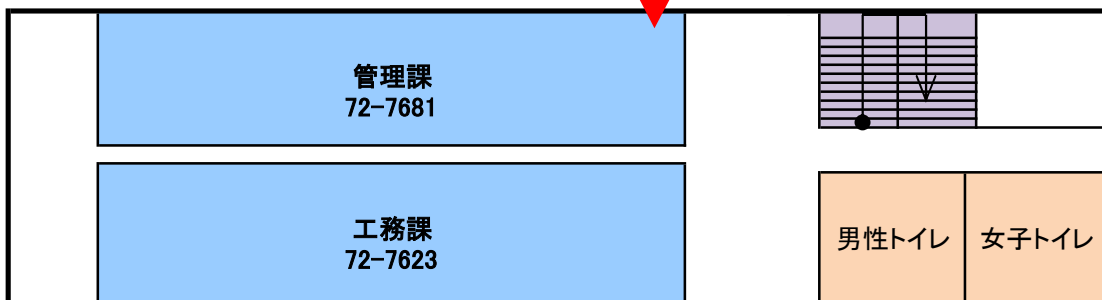

三好市保健センター

〒778-0004
三好市池田町シンマチ1476番地1

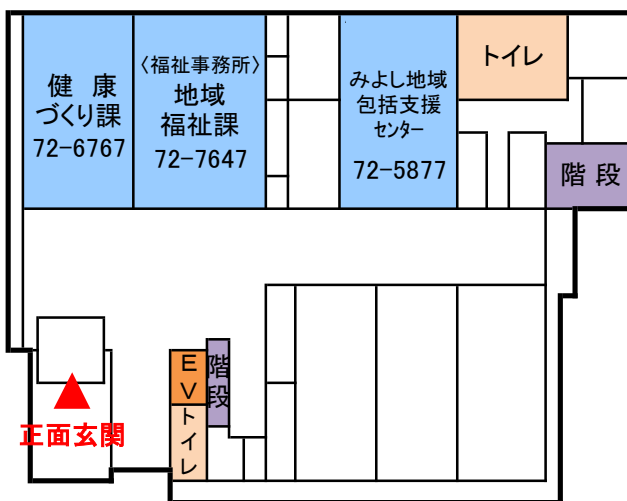

三好市子育て支援センター

〒778-0004
三好市池田町シンマチ1474番地

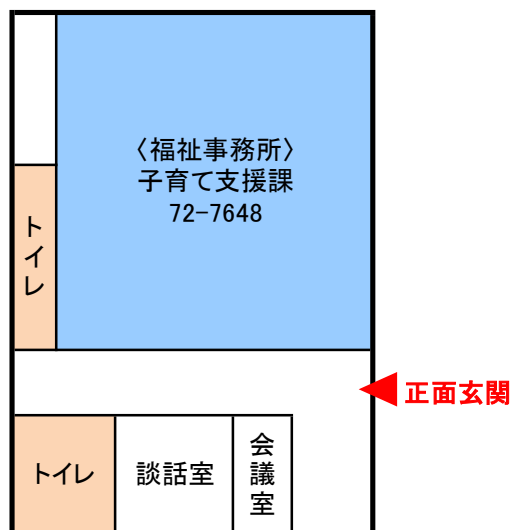

三好市環境課詰所

〒778-0004
三好市池田町シンマチ1395番地1

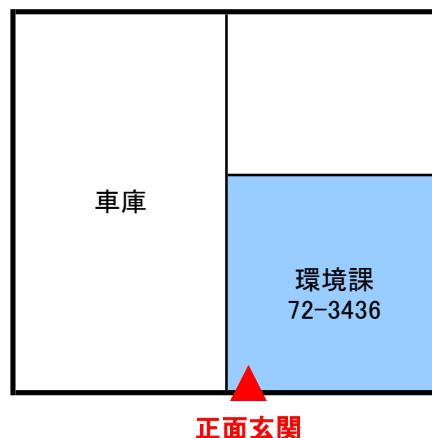



教育委員会 1階

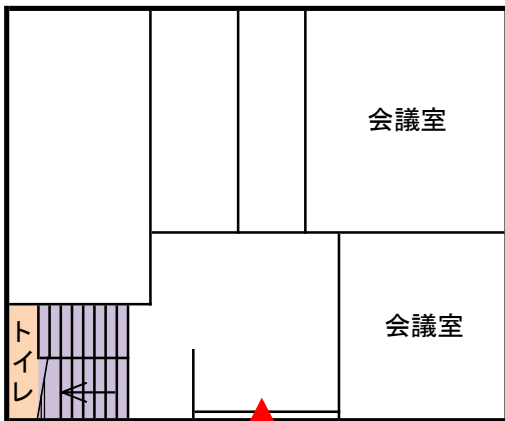

正面玄関

教育委員会 2階

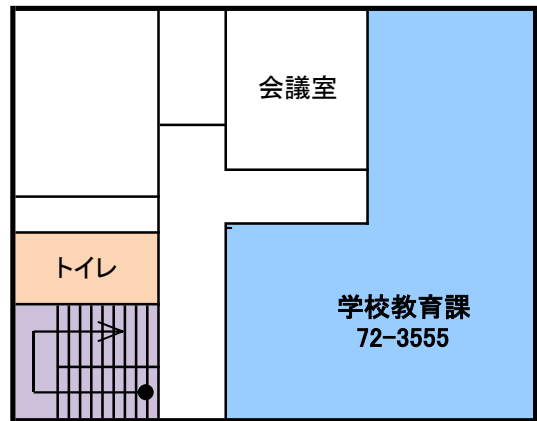

教育委員会 3階

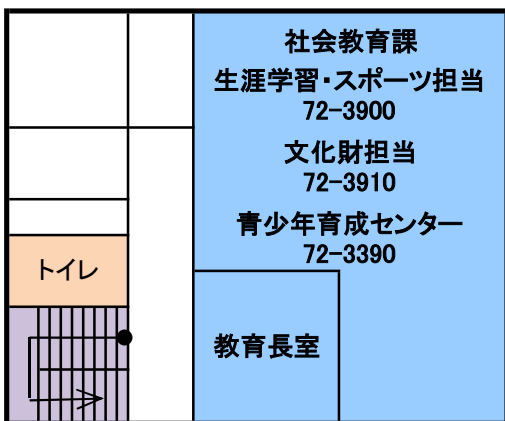

三野支所

〒771-2395 三好市三野町芝生1039番地
TEL 77-2311(代)

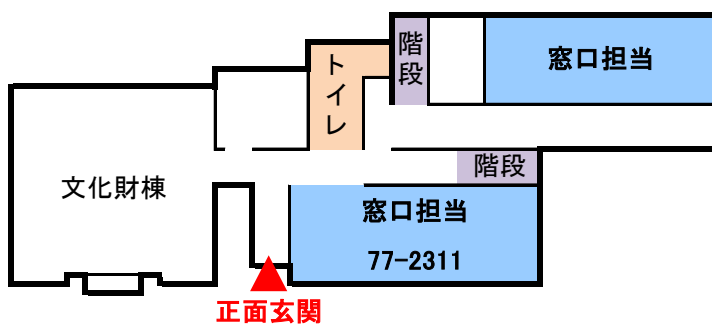

井川支所

〒779-4895 三好市井川町辻73番地
TEL 78-5001(代)

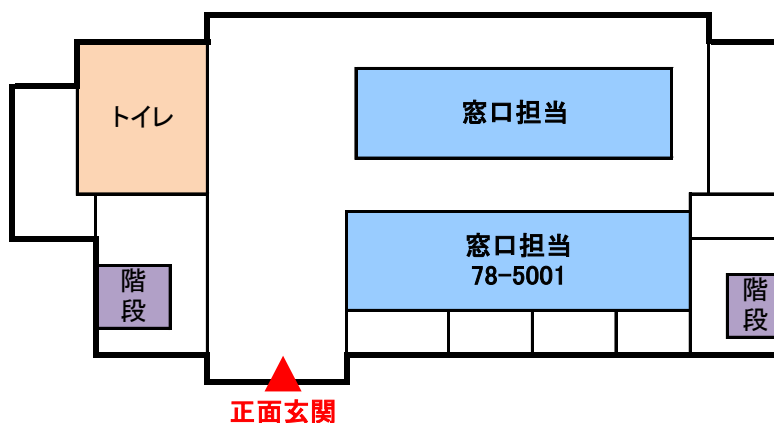

山城支所

〒779-5395 三好市山城町大川持586番地6
TEL 86-1111(代)

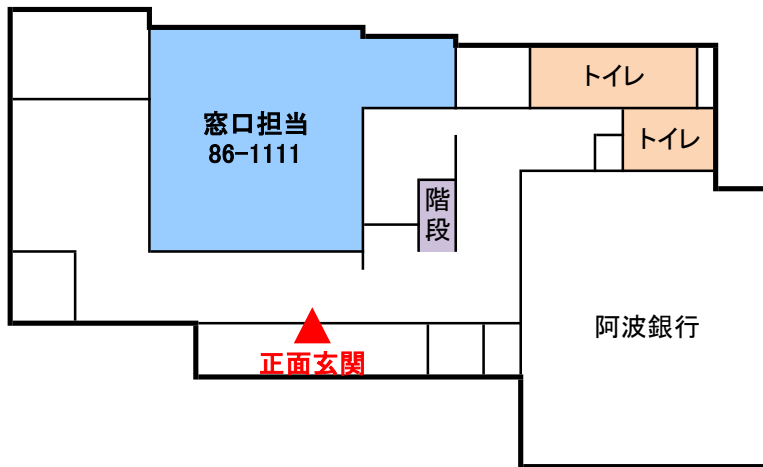

地籍調査課(旧山城支所2階)

〒779-5304 三好市山城町大川持518番地9

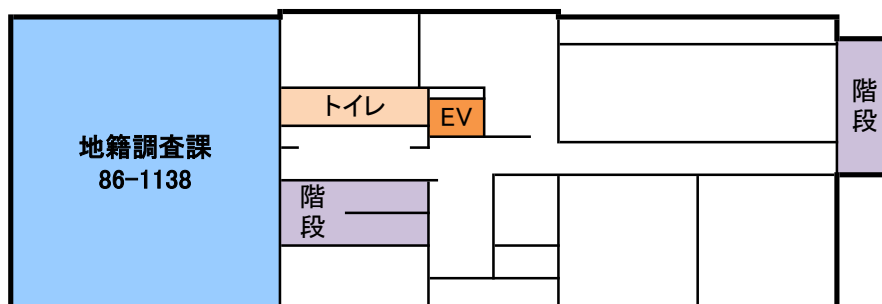

東祖谷支所

〒778-0295 三好市東祖谷京上157番地2
TEL 88-2211(代)

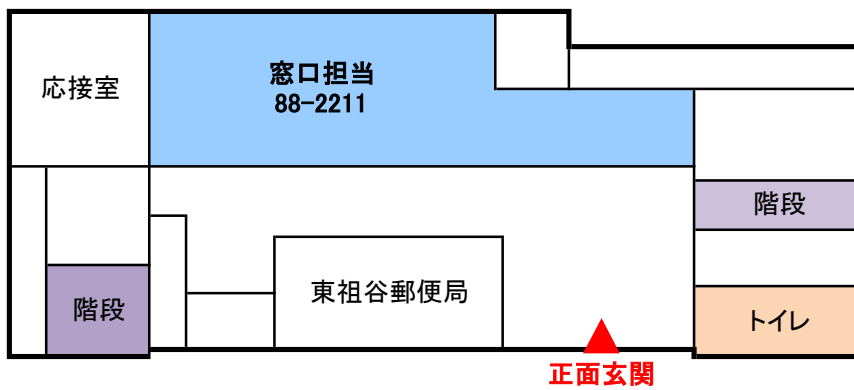

西祖谷支所

〒778-0195 三好市西祖谷山村一宇343番地2
TEL 87-2211(代)

